

Thank you for purchasing our product. Before attempting to connect or operate this product, please read the instructions carefully before use.

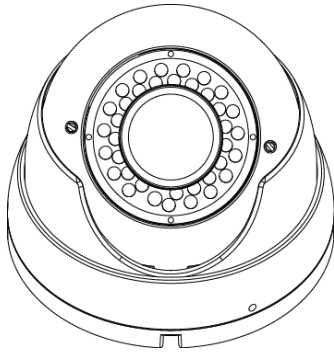

AV676PIR - Black
AV676PIRW - White

DESCRIPTION

AV676PIR(W) uses advanced imaging technology from SONY IMX238 CMOS sensor to capture image resolution as high as 720P@60FPS and outputs analog signal through CVBS/BNC. It features 2D/3D adaptive noise reduction. External button accesses camera's OSD menu to set Motion Detection, Privacy Zone, Digital Zoom, Digital Picture Correction, Shutter, White Balance, and other imaging features.

PRECAUTIONS

1. Use appropriate power supply.
The power input for AV676PIR(W) is DC12V. Using wrong power source will damage the camera permanently.
2. Do not attempt to disassemble the camera.
There is not serviceable parts.
3. Handle the camera with care.
Avoid abusing the camera by striking, shaking, or other improper handling.
4. Do not place the camera in the following locations:
 - a. Where temperature is lower than -4 °F or higher than 131 °F;
 - b. Where humidity is higher than 90%.
5. Clean the CMOS faceplate with care.
Do not use strong detergents. Use a piece of lens tissue or cotton tipped applicator and ethanol.
6. Do not attempt to aim the camera at the sun.
Aiming at the sun or other extremely bright objects causes smear to appear irrespectively of whether the camera is operating or not. This can damage the CMOS.
7. Do not put the camera in places with interference.
When this camera is installed near the equipment like wireless communication device that emits strong electromagnetic field, some irregularities such as noise on the monitor screen may happen.

FEATURES

- Sony IMX138 720P CMOS Sensor
- CVBS/BNC 960H/720P@60FPS Video Output
- True Day & Night
- Motion Detection, Privacy Zones
- Adaptive 2D/3D Noise Reduction
- Ingress Protection Rated IP66: Dust & Weather Proof
- OSD Menu & External Button menu access

PARTS INSTRUCTIONS

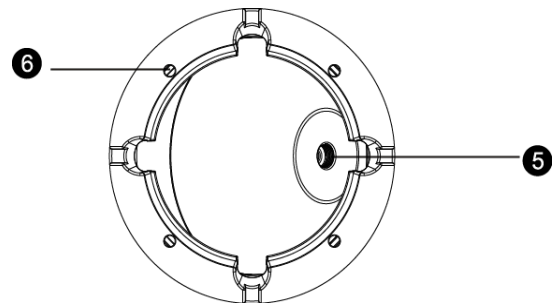
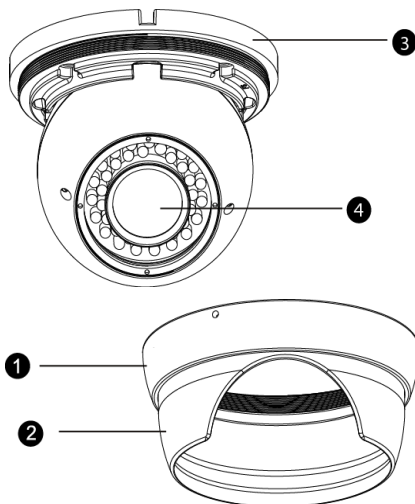

1. Ring Enclosure
2. Camera Holder
3. Base
4. Camera Lens
5. Wire Out Hole
6. Four install screws holes (on base)

DIMENSION

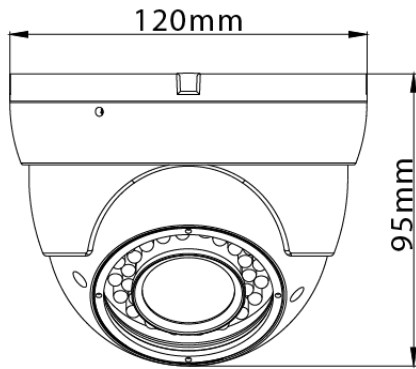

CONNECTIONS

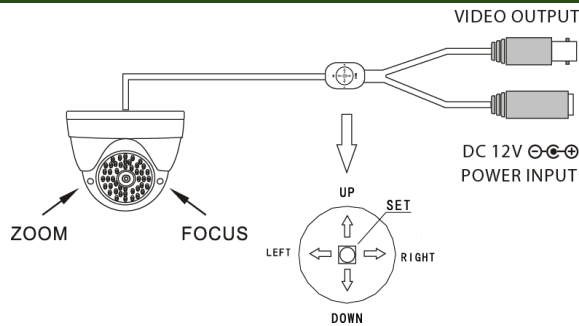

Use screwdriver to adjust zoom and focus.

SETUP

Camera Installation:

1. Unscrew the ring enclosure, take it out.
2. Using the foam pat to locate the holes in the wall.
3. Drill 4 holes in the position needed in accordance with the holes on the base. Push the expansion bolt inside, then screws the base to the expansion bolt holes loosely.
4. Get the wire out from the wire out hole through the base.
5. Screw tightly the base to the wall.
6. Screw the enclosure to the base with the ring enclosure.

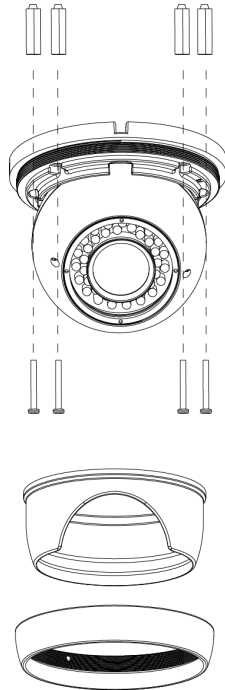

MENU

IMAGE ←	3D-NR ↔ AE MODE IMAGE ENHANCE ↔ FLIP ZOOM IN	IRIS ↔ WB MIRROR BRIGHTNESS
DAY & NIGHT	AUTO B&W	COLOR EXTERNAL
ZONE MASKING ←	STATUS VERTICAL SIZE VERTICAL MOVE	HORIZONTAL SIZE HORIZONTAL MOVE
MOTION DETECTION ←	STATUS HORIZONTAL SIZE HORIZONTAL MOVE	COLOR VERTICAL SIZE VERTICAL MOVE
VIDEO STANDARD	PAL	NTSC
LANGUAGE	ENGLISH	CHINESE
LOAD DEFAULT		
SOFT VERSION		
SAVE & EXIT		

SPECIFICATIONS

Sensor	1/3" SONY IMX238 CMOS
Effective Pixels	1.3 Megapixels
Scanning System	2:1 Interlaced
Sync. System	Internal
Resolution	720P (equal to 1000TVL)
Lens	2.8-12mm Varifocal
White Balance	AUTO
Electronic Shutter	AUTO
OSD	Built-in with external access button
White Balance	AWB-PRO/AWB-TEMP/AWB-AI/AWB-GW/AWB-CCT
Backlight Compensation (BLC)	ON/OFF/AUTO
Noise Reduction	3D Noise Reduction
Motion Detection	Off/On (4 Areas)
Privacy Zones	Off/On (8 Areas)
Day & Night	Auto / B&W / Exton / Color
S/N Ratio	> 50dB (AGC Off)
Video Output	1.0V p-p Composite Video Output, 75Ω
IR LED	36 pcs IR LED (∅5mm/850nm)
IR Distance	100 Feet / 30 Meters
Min. Illumination	0 Lux (IR On)
Power Supply	DC 12V ± 10%
Power Consumption	300mA, 3.6W
Operating Temp.	-4 ~ 131 °F / -20 ~ 55 °C
Dimension (∅ x H)	∅4.72 x 3.74 inches / ∅120 x 95 mm
Weight	1.81 lb / 820g