

AV134IPWD-40 4 MP EXIR Bullet Network Camera



Specification

- 1/3" Progressive Scan CMOS
- Up to 4 megapixel resolution
- 120dB Wide Dynamic Range
- 3D DNR
- EXIR high performance LEDs
- Up to 50 meters IR range

Dimensions

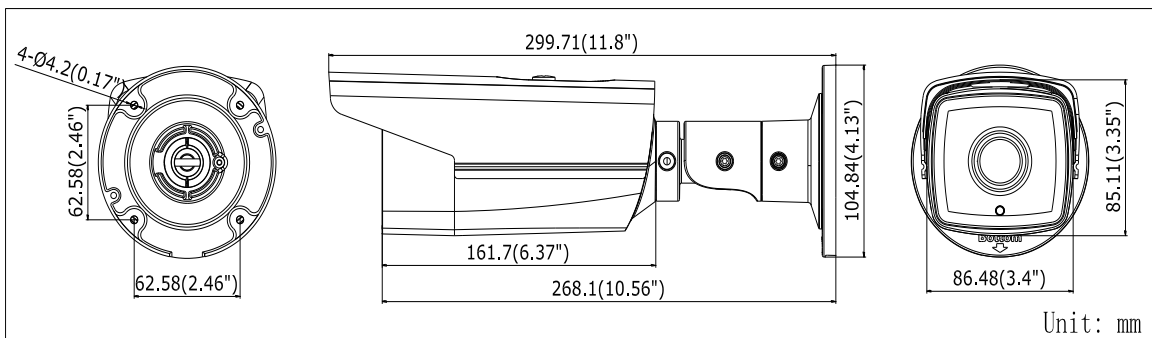

Specification

Camera	
Image Sensor	1/3" Progressive Scan CMOS
Min. Illumination	0.01Lux @(F1.2,AGC ON), 0.028Lux @(F2.0,AGC ON), 0 Lux with IR
Shutter Speed	1/3 s ~ 1/10,000 s
Slow Shutter	Support
Lens	4mm @F2.0
Lens Mount	M12
Day & Night	IR cut filter with auto switch
WDR	120dB
Compression Standard	
Video Compression	H.264/MJPEG/H.264+
H.264 Type	Main Profile
Video Bit Rate	32 Kbps – 16 Mbps
Image	
Max. Resolution	2688 × 1520
Frame Rate	50Hz: 20fps (2688×1520), 25fps(1920×1080), 25fps(1280×720) 60Hz: 20fps (2688×1520), 30fps (1920×1080), 30fps(1280×720)
Image Enhancement	BLC/3D DNR/ROI
Image Setting	Rotate Mode, Saturation, Brightness, Contrast, Sharpness adjustable by client software or web browser
Day/Night Switch	Auto/Schedule/Triggered by Alarm In
Network	
Network Storage	NAS (Support NFS,SMB/CIFS)
Alarm Trigger	Intrusion Detection, Line Crossing detection, Motion detection, Dynamic Analysis, Tampering alarm, Network disconnect, IP address conflict, Storage exception
Protocols	TCP/IP, UDP, ICMP, HTTP, HTTPS, FTP, DHCP, DNS, DDNS, RTP, RTSP, RTCP, PPPoE, NTP, UPnP, SMTP, SNMP, IGMP, 802.1X, QoS, IPv6, Bonjour
Security	Flash-prevention, dual stream, heartbeat, mirror, password protection, privacy mask, watermark, IP address filtering, Anonymous access
Standard	ONVIF (PROFILE S, PROFILE G), PSIA, CGI, ISAPI
General	
Communication Interface	1 RJ45 10M/100M Ethernet interface
Operating Conditions	-30 °C – 60 °C (-22 °F – 140 °F), Humidity 95% or less (non-condensing)
Power Supply	12V DC±10%, PoE (802.3af)
Power Consumption	Max. 7.5W
Ingress Protection level	IP66
IR Range	50 meters
Dimensions	299.71 × 86.48 × 85.11(11.8" × 3.4" × 3.35")
Weight	1200g (2.65 lbs)
Order Model	